





Round Eyelets























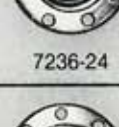

	Flange Diameter in inches	Barrel Diameter in inches	Length Under Flange in inches		Flange Diameter in inches	Barrel Diameter in inches	Length Under Flange in inches
 4784-10 w	.233	.146	.160	 3651-18 w	.467	.345	.158
 4795-12 w	.270	.168	.142	 6554-18 w	.474	.338	.184
 3612-12 w	.310	.118	.178	 6485-18 w	.490	.226	.183
 E11-12 w	.310	.190	.133	 6899-20 w	.495	.280	.150
 4796-14 w	.325	.190	.155	 6821-20 w	.496	.272	.187
 6816-16 w	.385	.223	.163	 6705-20 w	.497	.267	.164
 6610-16 w	.387	.220	.160	 6713-20 w	.497	.276	.183
 6280-18 w	.450	.272	.188	 7082-20 w	.500	.263	.143
 6579-18 w	.454	.223	.174	 6488-20 w	.525	.237	.143

(w = washer available)

(w = washer available) 5-1

Round Eyelets

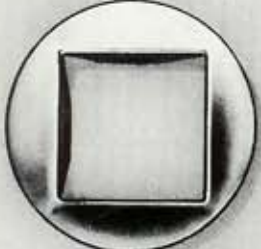
	Flange Diameter	Barrel Diameter	Length Under Flange		Flange Diameter	Barrel Diameter	Length Under Flange
	in inches	in inches	in inches		in inches	in inches	in inches
 7243-24	.569	.217	.139	 6400-28	.632	.353	.154
				w			
 7244-24	.586	.328	.173	 6714-24	.632	.360	.165
w				w			
 6489-30	.708	.342	.173	 7232-24	.651	.275	.147
w				w			
 6468-24	.589	.351	.180	 3676-28	.684	.528	.152
w				w			
 6276-28	.600	.342	.170	 E30-30	.762	.526	.147
w				w			
 6277-28	.600	.342	.188	 7242-36	.810	.436	.203
w							
 6838-24	.600	.344	.154	 6173-36	.870	.621	.224
w				w			
 7236-24	.625	.326	.157	 6483-36	.905	.487	.170
w				w			
 7230-24	.630	.335	.150	 6482-36	.905	.491	.263
w				w			
 6544-28	.632	.351	.170				
w							



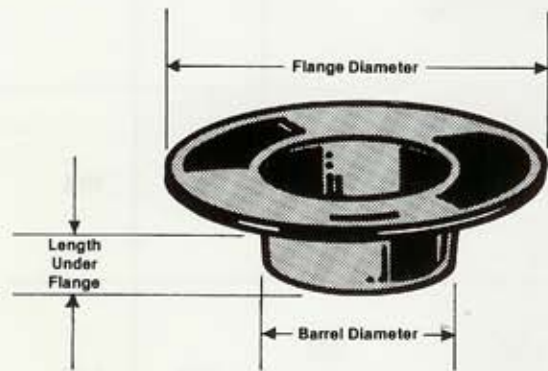





	Flange Diameter	Barrel Diameter	Length Under Flange		Flange Diameter	Barrel Diameter	Length Under Flange
	in inches	in inches	in inches		in inches	in inches	in inches
 E40-40 W	.919	.666	.152	 6492-40 W	1.020	.620	.153
 4483-60 W	1.318	.775 x .775	.180	 6168-60 W	1.500	.830	.221



We will service your eyelet needs quickly and efficiently. We offer automatic eyelet attaching equipment at very realistic prices. Ask for information on our #E67/R machines.

Eccentric Eyelets



	Flange Diameter	Barrel Diameter	Length Under Flange		Flange Diameter	Barrel Diameter	Length Under Flange
	in inches	in inches	in inches		in inches	in inches	in inches
 4188-16 W	.348	.176	.140	 7011-20 W	.500	.263	.150
 6484-14 W	.355	.175	.149	 6819-30 W	.660	.342	.178
 4066-16 W	.356	.177	.132	 7245-30 W	.663	.339	.180
 3918-20	.495	.271	.187	 4162-28 W	.670	.349	.143









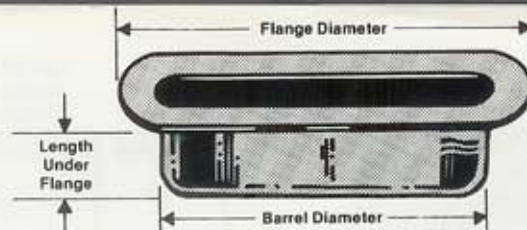







(w = washer available)

(w = washer available) 5-3



















Oval Eyelets



	Flange Diameter in inches	Barrel Diameter in inches	Length Under Flange in inches		Flange Diameter in inches	Barrel Diameter in inches	Length Under Flange in inches
 4797-14 w	.353 x .221	.240 x .111	.177	 1734-70 w	1.780 x .830	.736 x .290	.318
 3568-16	.401 x .264	.309 x .172	.147		 2216-70 w	1.780 x .830	.736 x .290
 6470-18	.435 x .312	.277 x .170	.134	 4798-18		.642 x .518	.260
 2294-20	.530 x .348	.372 x .195	.179	 4238-36	.784 x .553	.213	.178
 3567-20	.531 x .346	.387 x .292	.126	 4161-36 w	.868 x .675	.357	.120
 4799-24	.675 x .210	.580 x .114	.172	 6480-36 w	.939 x .555	.343	.195
 4800-36	.919 x .373	.748 x .200	.246	 6836-36 w	.945 x .563	.342	.164
 2270-36	.940 x .502	.713 x .305	.235	 2465-40 w	1.008 x .650	.832 x .455	.203

Square Eyelets











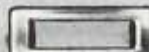



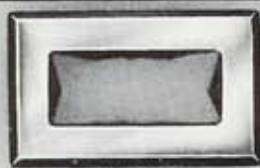

	Flange Diameter	Barrel Diameter	Length Under Flange		Flange Diameter	Barrel Diameter	Length Under Flange
	in inches	in inches	in inches		in inches	in inches	in inches
 3565-10	.237 x .237	.163 x .163	.140	 6063-45 w	.809 x .809	.527	.152
 4788-16	.307 x .307	.166 x .166	.175	 3647-45 w	.858 x .858	.546 x .546	.140
 4846-16	.314 x .314	.182 x .182	.192	 7241-45 w	1.067 x .929	.504	.174
 6504-20 w	.452 x .452	.218	.168	 6502-50	1.255 x 1.055	.738	.187
 4874-20	.507 x .444	.226	.177	 4478-70 w	1.318 x 1.318	.775 x .775	.180
 4773-30 w	.535 x .535	.354	.122	 1606-34 w	.594 x .594	.300 x .300	.115
 7231-30 w	.771 x .586	.334	.170	 4482-10 w	1.318 x 1.425	.775 x .775	.180
 6467-24 w	.605 x .515	.356	.187	 6396-80 w	1.511 x 1.511	.813	.200
 6240-30 w	.600 x .600	.344	.207				

(w = washer available)

(w = washer available) 5-5















Rectangular and Triangular Eyelets

	Flange Diameter	Barrel Diameter	Length Under Flange		Flange Diameter	Barrel Diameter	Length Under Flange
	in inches	in inches	in inches		in inches	in inches	in inches
 4779-16	.326 x .184	.264 x .112	.124	 3878-36	.778 x .294	.570 x .135	.210
 3771-16	.368 x .245	.299 x .148	.118	 4509-40	.960 x .709	.585 x .296	.257
 4008-20	.427 x .322	.200	.180	 1607-45	1.067 x .630	.725 x .279	.135
 1603-28	.472 x .424	.375 x .314	.177	 E70-70	1.309 x .810	.888 x .390	.162
 4780-22	.512 x .268	.388 x .143	.143	 3566-12	.326 x .326	.193 x .193	.136
 3636-24	.551 x .294	.440 x .142	.186	 4789-14	.365 x .365	.220 x .220	.169
 2339-30	.650 x .442	.472 x .225	.194	 1604-30	.586 x .586	.364 x .364	.168
 6417-36	.675 x .587	.352	.155	 6171-28	.634 x .551	.366	.183
 1605-34	.738 x .537	.499 x .255	.180	 6481-30	.678 x .620	.342	.172

Hexagon and Odd Shaped Eyelets

























	Flange Diameter	Barrel Diameter	Length Under Flange		Flange Diameter	Barrel Diameter	Length Under Flange
	in inches	in inches	in inches		in inches	in inches	in inches
 4793-12 w	.308 x .270	.179	.155	 4175-14 w	.317	.127	.140
 4794-14	.352 x .314	.201	.167	 4176-14 w	.327	.126	.140
 4792-16 w	.431 x .378	.180	.150	 4790-18	.411	.216	.150
 4791-16	.431 x .378	.216	.172	 6474-18	.468	.218	.160
 7249-16	.440 x .385	.204	.162	 4007-20	.476 x .425	.204	.180
 6423-24 w	.518 x .518	.360	.140	 7238-36 w	.739	.331	.147
 6424-24 w	.587 x .508	.342	.233	 6605-60 w	1.508 x 1.508	.823	.197
 3915-24	.602 x .678	.412 x .135	.170				
 7233-24 w	.634 x .556	.337	.177				



















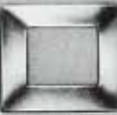

(w = washer available)

(w = washer available) 5-7

Odd Shaped Eyelets

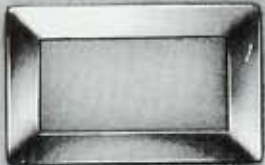
	Flange Diameter	Barrel Diameter	Length Under Flange		Flange Diameter	Barrel Diameter	Length Under Flange
	in inches	in inches	in inches		in inches	in inches	in inches
 6476-40 w	.522	.343	.218	 7240-30 w	.695 x .594	.345	.210
 6454-20 w	.527	.269	.150	 6690-30 w	.702 x .705	.343	.134
 6490-20 w	.567	.241	.147	 6453-30 w	.708	.352	.150
 6691-24 w	.596	.350	.180	 6601-30 w	.710	.355	.178
 7247-28 w	.634	.281	.220	 6599-30 w	.710	.357	.174
 7235-30 w	.672 x .610	.348	.181	 6602-30 w	.712	.354	.155
 7234-36 w	.675 x .674	.333	.174	 7237-30 w	.757 x .439	.347	.178
 6693-28 w	.684 x .606	.343	.121	 6487-30 w	.787 x .681	.344	.195
 7246-30 w	.692 x .688	.344	.173	 6486-36 w	.839 x .686	.349	.185
 7239-30 w	.695 x .594	.336	.186	 6491-36 w	.848	.346	.178

	Flange Diameter	Barrel Diameter	Length Under Flange		Flange Diameter	Barrel Diameter	Length Under Flange
	in inches	in inches	in inches		in inches	in inches	in inches
	1.240 x .896	.757 x .270	.305		2.022 x 1.507	.808	.215
1735-45				6606-80			

Outside Diameter	Inside Diameter	Outside Diameter	Inside Diameter	Washers 	
 E11W	.342 .203	 6277W	.601 .356		
 4729W	.365 .132	 7301W	.602 .170	 1607W	Outside Diameter 1.058 x .617 Inside Diameter .788 x .338
 4658W	.365 .165	 6651W	.627 .367	 2465W	1.141 x .795 .837 x .484
 3548W	.403 x .267 .262 x .117	 2263W	.630 x .558 .371 x .310	 6168W	1.370 .848
 3918W	.408 .270	 E30W	.722 .548		
 6280W	.515 .290	 3647W	.922 x .922 .580 x .580	 E70W	1.315 x .830 .972 x .485
 1606W	.595 x .595 .370 x .370	 E40W	.976 .690	 4478W	1.322 x 1.322 .892 x .892
 3736W	.598 .410				



Eyelets



7362-20



7444 W-16



7681L-16



7377-20



7456-20



7772-16



7387-18



7470-20



7783-16



7392-20



7501-20



7854-16



7430-20



7505-20



7855-16



7433-28



7516-20

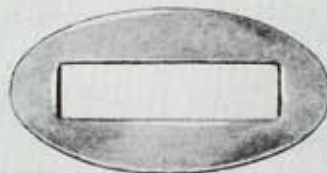

7533-70



7457-28



7652-20

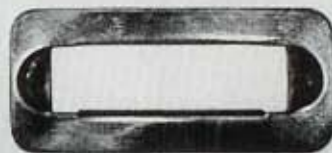

7533W-70